



**HORTITEK®**

**MULTI-BAR  
RANGE**

INSTRUCTION MANUAL



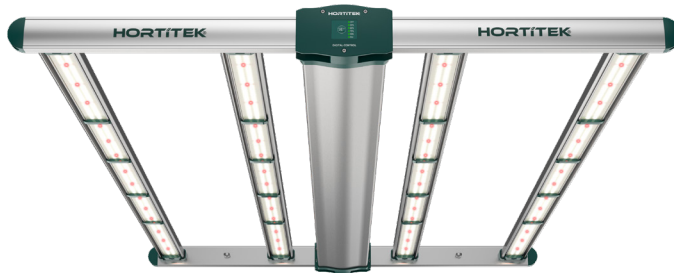

**FOUR BAR**

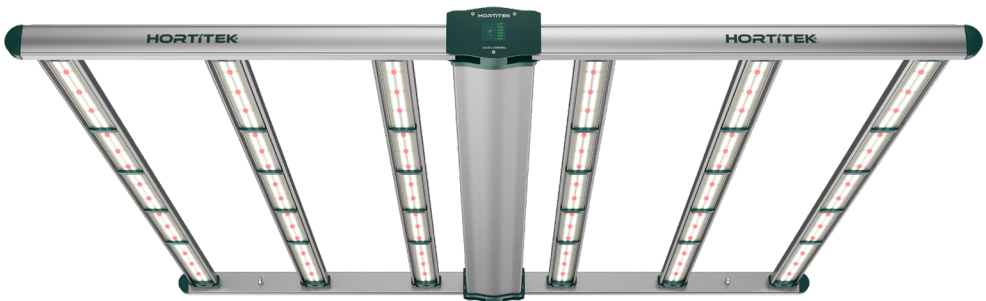

**SIX BAR**



## PRODUCT SPECIFICATIONS

Product Code		M4443	M4444
Power		410W	620W
Voltage Range / Frequency		100-277V ~ 50/60Hz	
Current	Amp @ 120V:	3.55A	5.45A
	Amp @ 208V:	2.00A	3.00A
	Amp @ 220V:	1.90A	2.85A
	Amp @ 230V:	1.85A	2.75A
	Amp @ 240V:	1.76A	2.65A
	Amp @ 277V:	1.55A	2.30A
PPF Efficacy		2.5 $\mu$ mol/J	
Max PPF		1025 $\mu$ mol/s	1550 $\mu$ mol/s
CCT		4000K	
CRI		85%	
PF		>0.95	
THD		<10%	
Beam Angle		120°	
Control Panel		OFF / 25% / 50% / 75% / 100% / RC	
External Control		Compatible with 0-10V LED Controllers	
Signal Cable		3.5mm TRS Male Jumper Cable	
Thermal Management		Passive	
BTU/h		1399	2116
Protection		Over Voltage, Short Circuit, Over Power, Over Temperature	Over Voltage, Short Circuit, Surge
Dimensions		1174x792x67mm 46.2x31.2x2.6"	1174x1172x67mm 46.2x46.1x2.6"
Weight		7.04kg $\pm$ 0.3kg   15.52 $\pm$ 0.66lbs	9.1kg $\pm$ 0.3kg   21.1 $\pm$ 0.66lbs
Working Temperature		0°C to 40°C /32°F to +104°F (95% RH)	
Storage Temperature		-40°C to 70°C /-40°F to +158°F (85% RH)	
IP Rating		IP65	
Warranty		3 Years	
Certificates		   	

## COVERAGE AREA

Fixture	Four Bar 410W			Six Bar 620W		
	Veg	Flower		Veg	Flower	
<sup>1</sup> Hanging Height (cm)	60	30	20	70	30	20
Max PPFD ( $\mu\text{mol/s/m}^2$ )	500	830	930	500	850	950
Coverage Dimensions LxW (m)	1.80 X 1.80	1.30 X 1.16	1.20 X 1.10	1.88 X 2.02	1.35 X 1.50	1.25 X 1.45
<sup>2</sup> Coverage Area ( $\text{m}^2$ )	3.24	1.55	1.32	3.80	2.02	1.82

<sup>1</sup>Hanging Height refers to the distance between the plant canopy and the LED.

<sup>2</sup>Coverage Area refers to the region that the plants receive at minimum 200PPFD for Flowering and 100PPFD for Vegetative.

## DIMENSIONS (mm/inch)

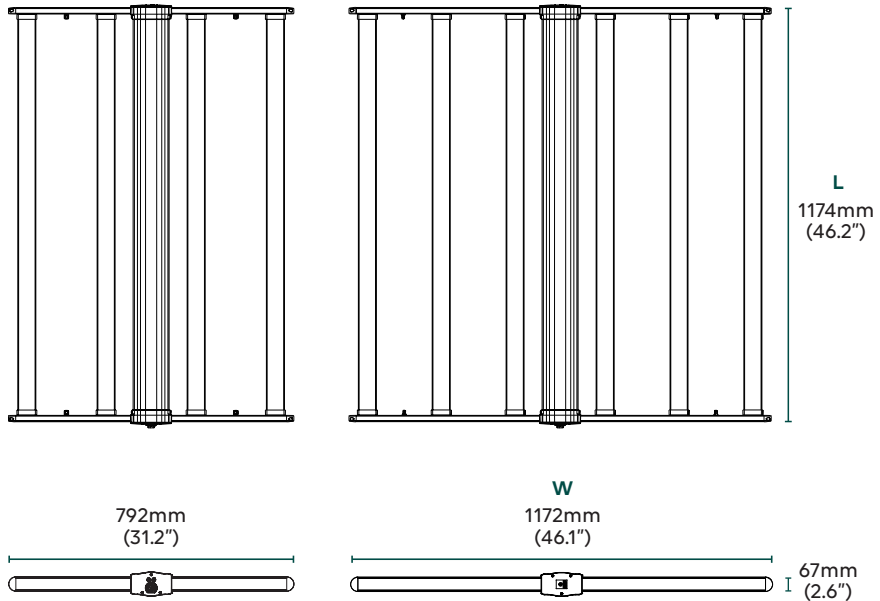

## INSTALLATION INSTRUCTIONS

**⚠ SAFETY NOTE: DO NOT REMOVE LED COVERS**

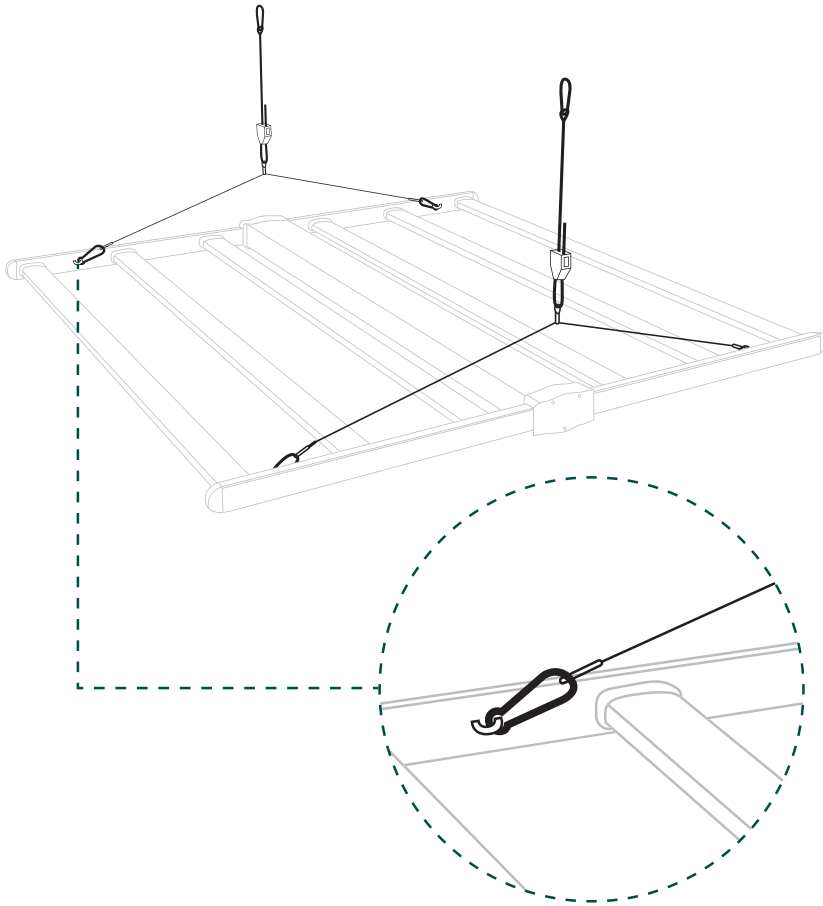

Attach lance hangers to fixture hanging tabs. Using two people, lift fixture into position, ensuring rope ratchets are secure.

## OPERATION INSTRUCTIONS



### POWERING ON

Connect the power cable to the driver and a switched off, power outlet. Switching the power outlet on will power the fixture. By default it will be set to 'OFF', use Digital Control to change settings.

### DIGITAL CONTROL

Use the 'SET' button to toggle between Power, Dimming and Remote Control. Connect the 3.5mm Male Jumper Cable between the Controller and the 'IN' port on the fixture.

### CONNECTING MULTIPLE LED FIXTURES

To connect multiple fixtures, add Signal Cables between fixtures 'OUT' & 'IN' ports. Once connections are made, set the 'DIGITAL CONTROL' to 'RC' mode on all fixtures.

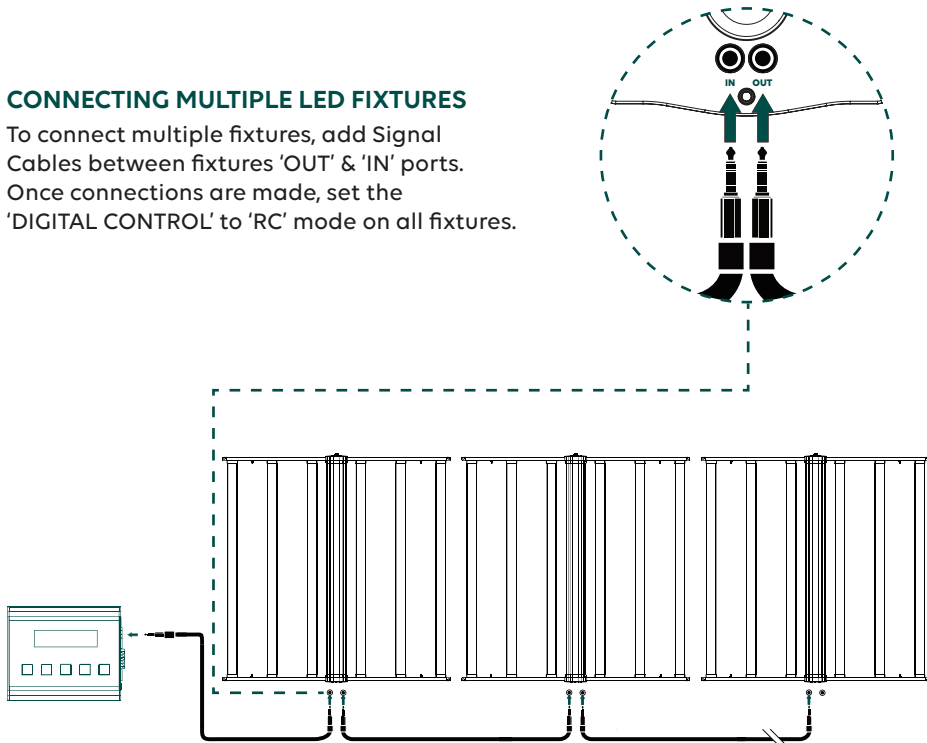

## WARRANTY - CONTACT YOUR RETAILER FOR WARRANTY CLAIMS AND SUPPORT

The company guarantees the mechanical and electronic components of this product. It ensures the materials and workmanship is free of defects, used under normal operating conditions.

If there are any defects with this product that relate to the workmanship or the materials used, the company shall, at its discretion, either replace or repair the product.

However, improper use is NOT covered by warranty. This includes but is not limited to, overloading, user error, physical or water damage.

Warranty is valid for a period of three years from the original date of purchase.

## SAFETY NOTES

- Ensure that there is no visible damage before installing or using this product.
- Keep away from hot objects and open flames.
- Avoid touching during operation.
- Ensure that selected power supply is switched OFF during installation.
- Do not install underwater or in water soaked areas.
- Do not attempt to service or replace LEDs yourself.
- The light source contained in this luminaire shall only be replaced by the manufacturer, service agent or similar qualified person.
- If the external cord/cable is damaged, it shall be exclusively replaced by the manufacturer, service agent or a similar qualified person in order to avoid a hazard.
- The external flexible cable or cord of this adapter cannot be replaced; if the cord is damaged, the adapter shall be scrapped.



**HORTITEK®**

[hortitek.com](http://hortitek.com)

